



*Finnish Defence  
Research Agency*

# **Radio Technical Evolution in the Finnish SDR Program**

**WinnComm Europe 2017  
Tactical Radio Workshop**

**Principal Scientist  
MSc (EE) Heikki Rantanen  
Finnish Defence Research Agency**



# *Outline*

1. From SDR demonstrator to tactical use of SDR in M18
2. Different operating environments, changing needs and potential solutions
3. Federated Mission Networking(FMN) – our framework to international interoperability
4. Towards cognitive radio in tactical radio networks
5. Conclusions



# ***From SDR demonstrator to tactical use of SDR in M18***



# Where we started...

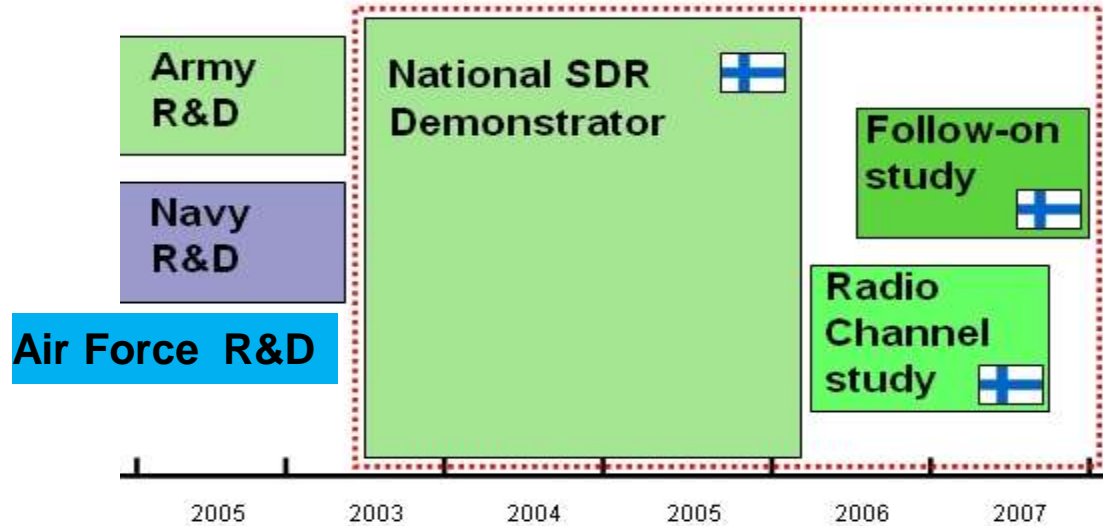

## National Tactical Positioning Waveform

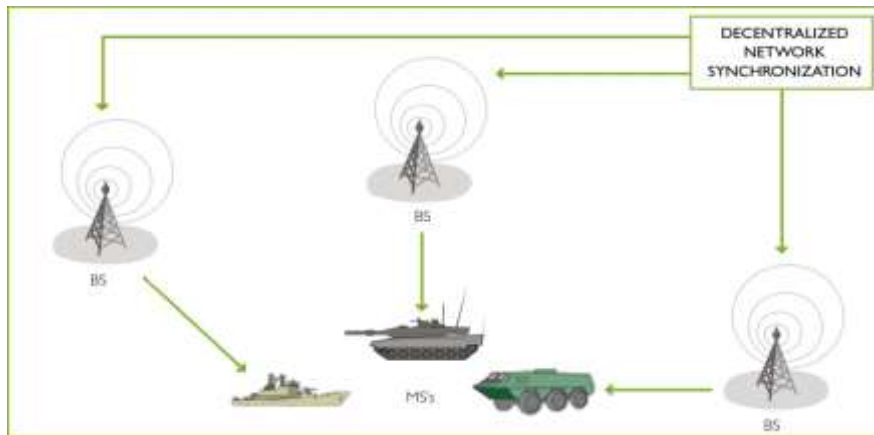

## Adaptive Wideband Networking Waveform

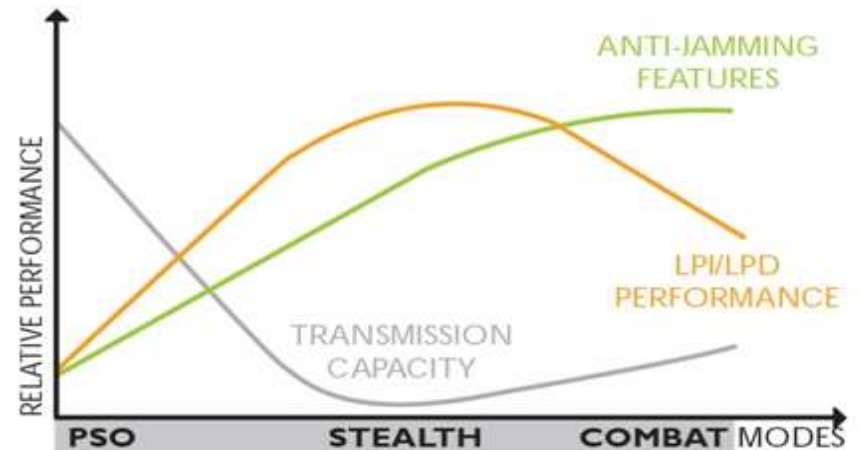



# ..then went to MN cooperation...

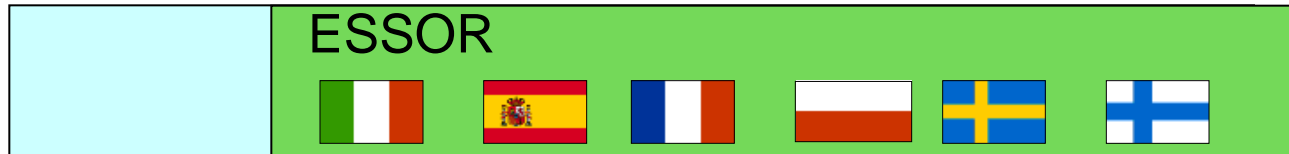

2007

2008

2009

2010

2011

2012





# Finnish C4I System M18

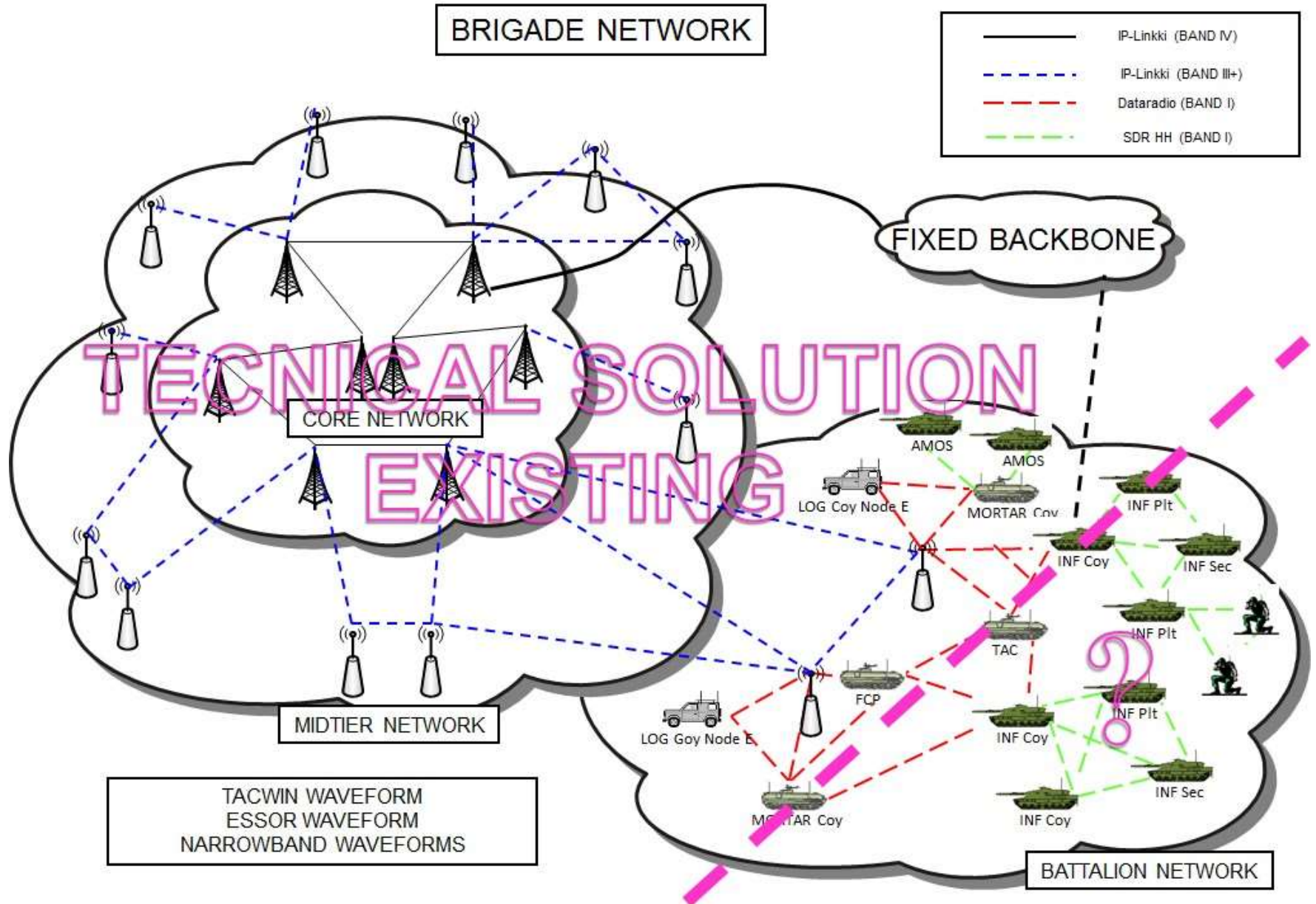



# Timeline of Finnish C4I System M18

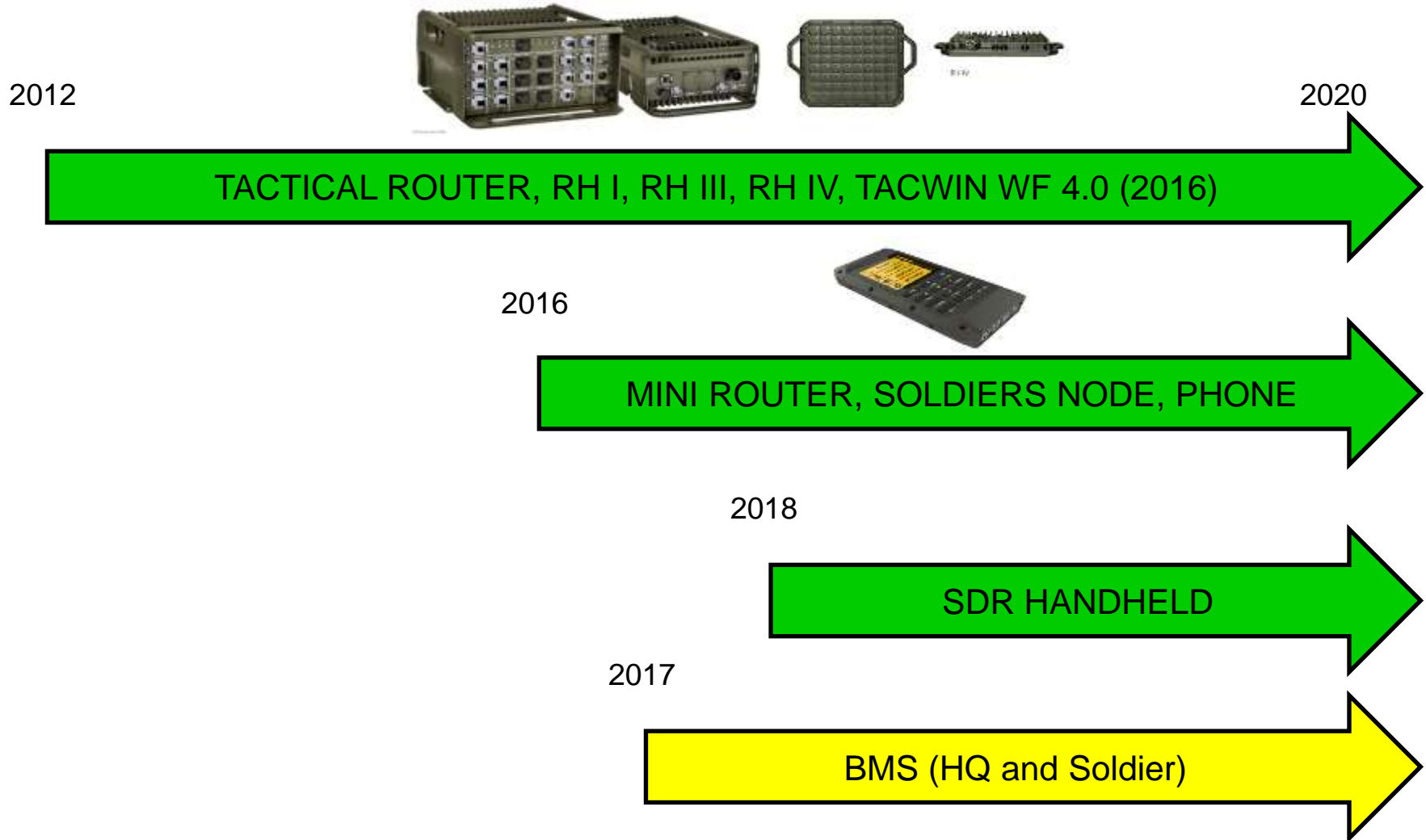



***Different operating environments,  
changing needs and potential  
solutions***





# Changing needs and potential solutions

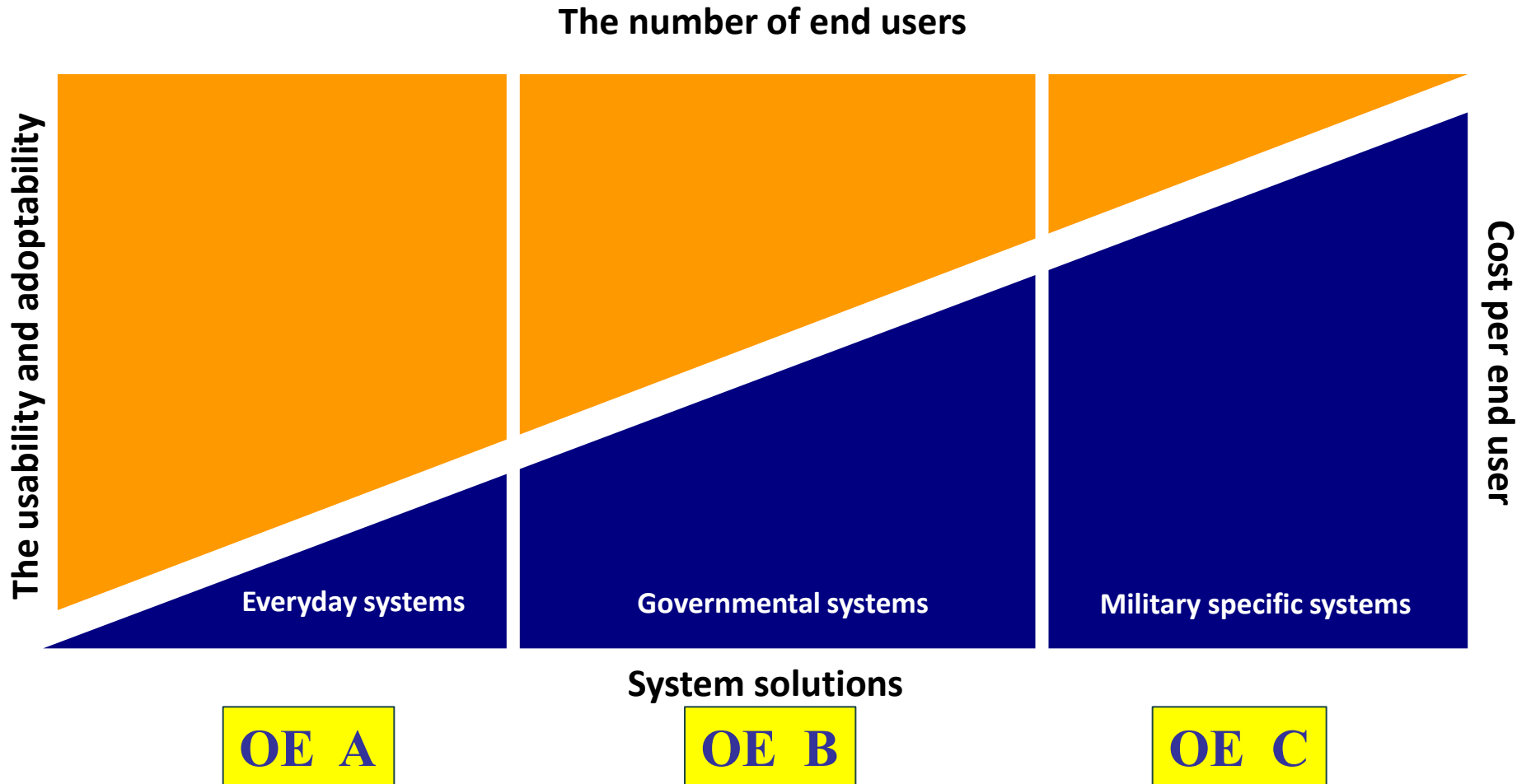



# QoS classes LTE Release 13

## Standardized QoS Class Identifier (23.203 Rel 13 Mar 2016)

Policy and charging control architecture

QCI	Traffic Class	Priority	Packet delay budget	Packet error loss rate	Resource type	Example Services
1	Conversational	2	100 ms	$10^{-2}$	GBR	Conversational Voice
2	Conversational	4	150 ms	$10^{-3}$	GBR	Conversational Video (Live Streaming)
3	Streaming	3	50 ms	$10^{-3}$	GBR	Real Time Gaming
4	Streaming	5	300 ms	$10^{-6}$	GBR	Non-Conversational Video (Buffered Streaming)
65		0.7	75 ms	$10^{-2}$	GBR	Mission Critical user plane Push To Talk voice (e.g., MC-PTT)
66		2	100 ms	$10^{-2}$	GBR	Non-Mission-Critical user plane Push To Talk voice
5	Interactive	1	100 ms	$10^{-6}$	Non-GBR	IMS Signalling
6	Interactive	6	300 ms	$10^{-6}$	Non-GBR	Video (Buffered Streaming) TCP-based (e.g., www, e-mail, chat, ftp, p2p file sharing, progressive video, etc.)
7	Interactive	7	100 ms	$10^{-3}$	Non-GBR	Voice, Video (Live Streaming) Interactive Gaming
8	Interactive	8	300 ms	$10^{-6}$	Non-GBR	Video (Buffered Streaming)
9	Background	9	300 ms	$10^{-6}$	Non-GBR	TCP-based (e.g., www, e-mail, chat, ftp, p2p file sharing, progressive video, etc.)
69		0.5	60 ms	$10^{-6}$	Non-GBR	Mission Critical delay sensitive signalling (e.g., MC-PTT signalling)
70		5.5	200 ms	$10^{-6}$	Non-GBR	Mission Critical Data (e.g. example services are the same as QCI 6/8/9)

Source: [http://niviuk.free.fr/store\\_lte.php](http://niviuk.free.fr/store_lte.php)



# 5G- welcome to OE A&B communication!

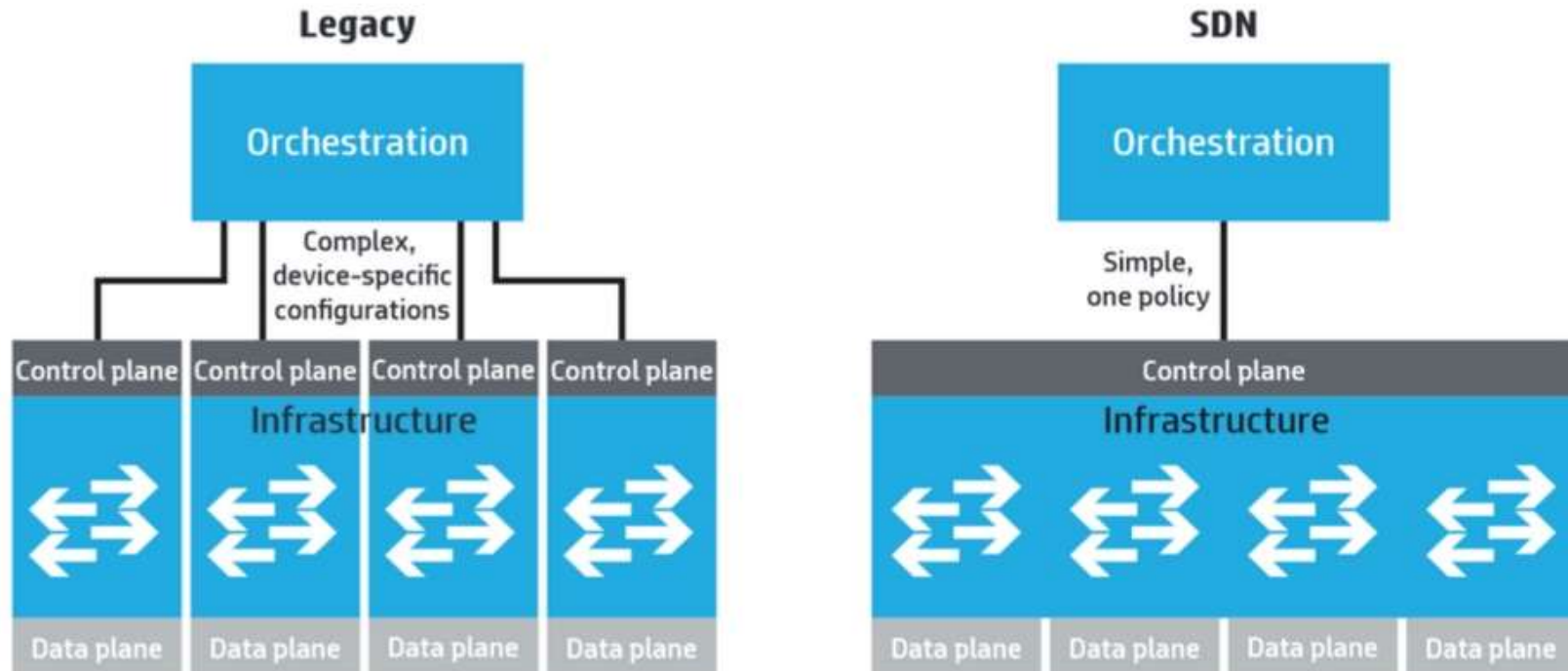

- Easier utilization of national communication infra for critical communication (CC)
  - Network Slicing – **“high priority highway for CC”**
- Advanced mobile networks
  - Higher data rates, **new tools for security, advanced priority mechanisms**, NFV
  - Massive MIMO Beamforming → **better LPI/LPD/AJ**
  - Low delay → **time critical MIL communication** (Radar data)
  - IoT communication → Sigfox, Lora type of **communication for sensors**



# ***Public Safety Operator in future?***

## **Dedicated public safety network**

Public safety operator deploys private LTE radio access and core network infrastructure solely to provide public safety services and applications over mobile broadband.

## **Hybrid solution**

Public safety operator has a network and/or spectrum sharing agreement with a commercial mobile network operator. The public safety operator may also implement a dedicated LTE network in key locations, while using the commercial network in other areas.

## **Fully commercial operator network based**

Commercial mobile operator provides the full network and all services for public safety users based on a negotiated service level agreement and price.

## **Mobile virtual network operator (MVNO)**

Public safety operator uses commercial mobile network infrastructure instead of deploying own network, but operates its own subscriber database, applications and billing services.

*Source: Making mission-critical mobile broadband a reality today, NOKIA*



# Research topics of CORE project 2013 - 2016

- Influence of new spectrum sharing concepts on the mobile communications networks and required new testing solutions from business, regulation, and technology perspectives.
- CORE++ showcased the feasibility of new sharing concepts (e.g. Licensed Shared Access (LSA)) for mobile broadband networks and them to other wireless systems including public safety.

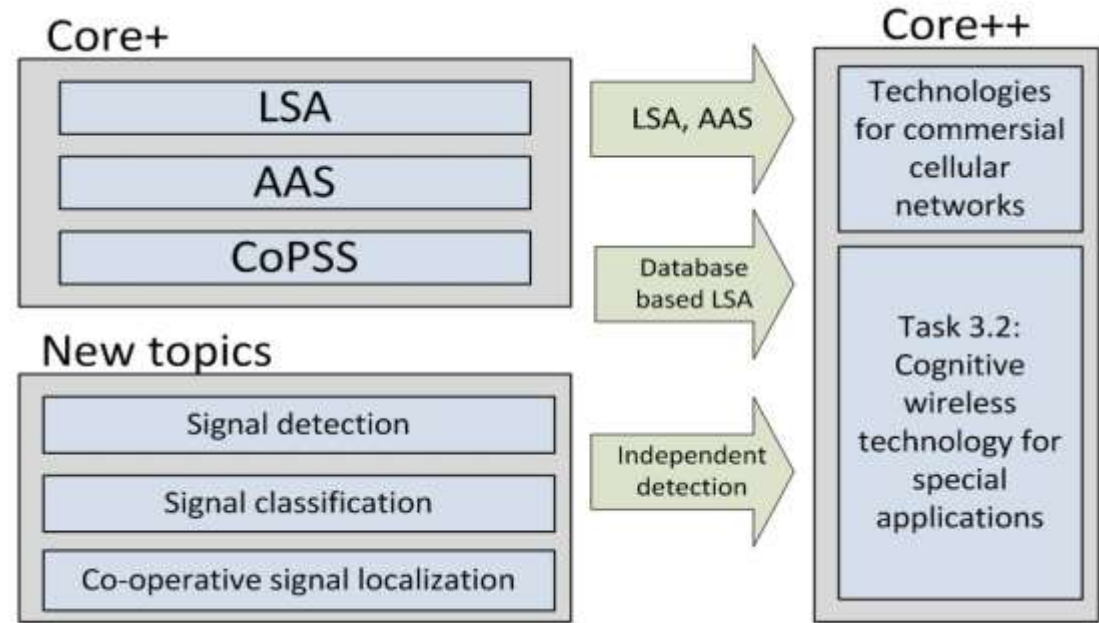



# *CORNET - Critical Operations over Regular Networks*

**Main overall research question:**

***“How every day’s technologies can be extended to cover special situations and applications”***





# ***CORNET Goals & Results***

The main goal of the CORNET project is to develop a test environment that allows:

- Ensuring the QoS for critical communications in commercial radio networks
- Testing movable temporary radio networks for the needs of public safety and security.

Expected results include:

1. The necessary radio network functionalities for QoS control and traffic prioritization
2. Network slicing
3. Temporary radio network deployment
4. Distributed network intelligence and functionalities
5. Privacy and security of critical communications in commercial networks with everyday communication devices.



***Federated Mission Networking(FMN) –  
our framework to international  
interoperability***





# Federated Mission Networking

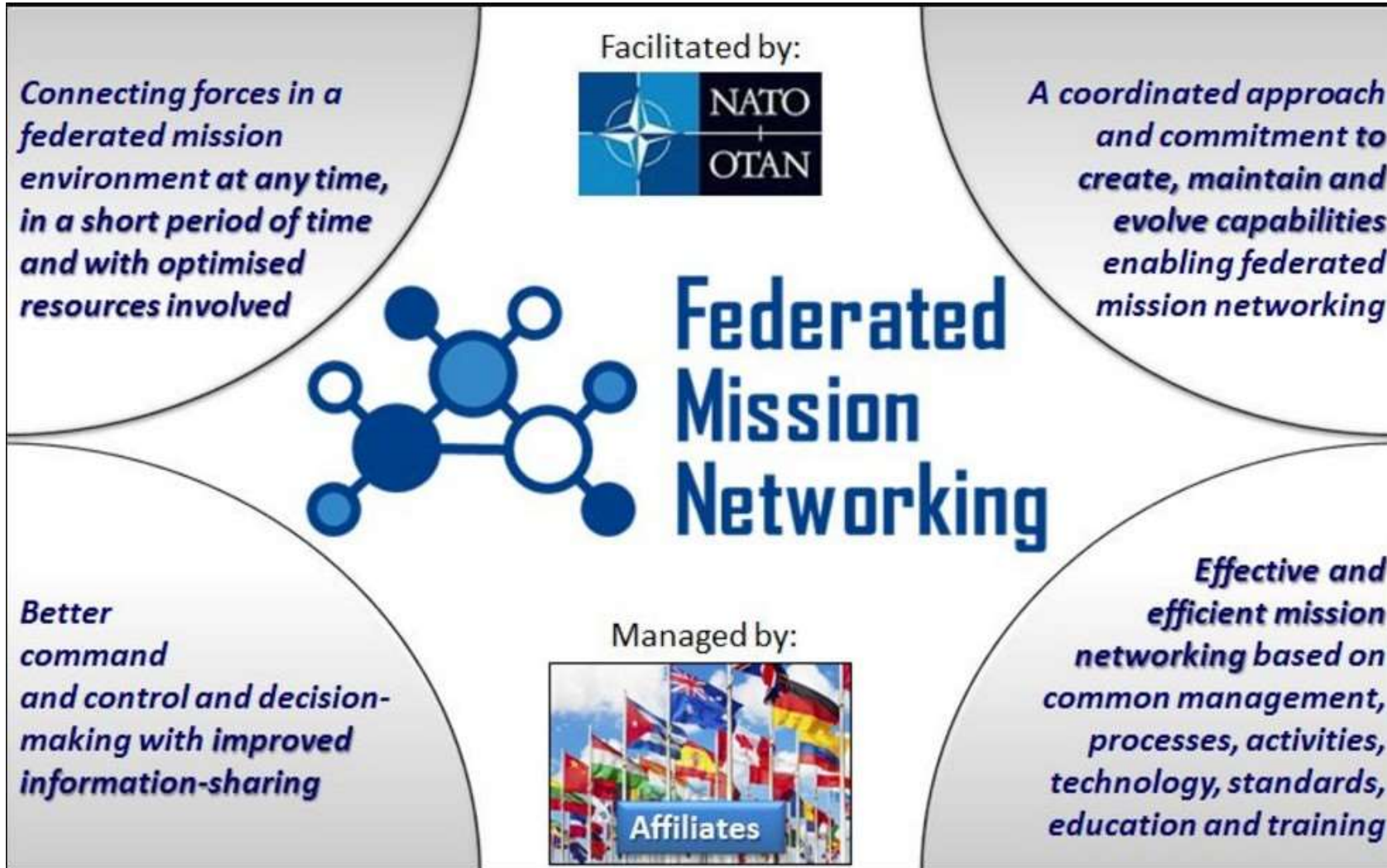

Picture: <https://dnbl.ncia.nato.int/FMN/SitePages/Home.aspx>



# ***Towards cognitive radio in tactical radio networks***



# *The key principle of success in the battlefield*

- The article writer of the referred magazine, using system theory and system models, concluded the following key principle to success in the battlefield:

***“By misleading, surprising, concealing and using principle of "act – counteract – counter counteract" maintain a comparative advantage to your enemy”***

*Source: Viestimies 2/2016, Sotilas- ja siviilitekniikan eroista – Mitä seuraa sodankäynnin perusominaisuuksista Osa 1, Lt. Col. (G.S.) (Ret.) Sakari Ahvenainen*



# *The key principle of success in tactical communication*

**To mislead** → the waveform must have different operating modes for peace- and wartime

**To surprise** → use e.g. spectrum in unexpected way

**To hide** → be ready to change master key, crypto algorithms etc. Use LPI/LPD communication

**To have comparative advantage** → do not reveal your ECCM capability at once, add it gradually as needed → adaptability of waveform

**➡ Only frequency agile cognitive radio can do this!**



# SDR HH implementation using RFIC + SoC

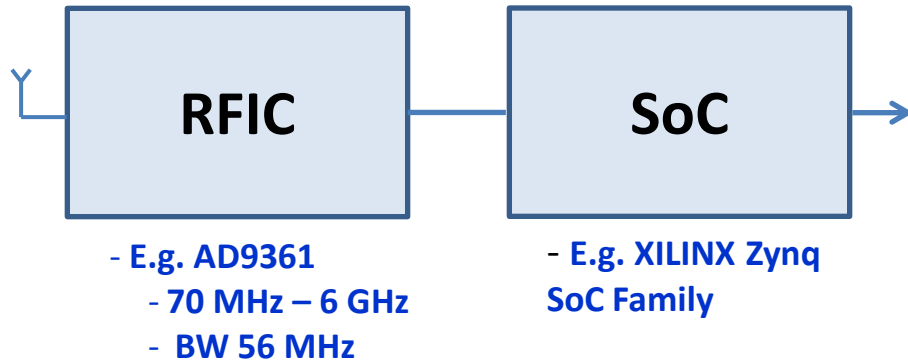

**Result: A low cost future proof cognitive SDR HH which can mislead, surprise and conceal → the winner of the game in OE C but also supports OE B (A) !**

- By sharing the architecture of low-cost experimental USRP supporting open source SDR community, we move from current waveform code porting to design flow sharing (that uses high level models).

*<http://www.epdtonthenet.net/article/78094/Tools-accelerate-SDR-exploration-and-development.aspx>*

- The main challenge is Information Assurance (IA) but modern SoC also offers new building blocks to this: ARM TrustZone®, Secure Boot, Virtualisation, Multi-core environment etc.

**➡ New approach in implementation/certification of the IA is needed (physical/logical separation etc.)**



# Needed features of SDR Handheld

- **Support of cognitive spectrum use**
  - Primary/secondary spectrum use i.e. LSA-type, based on databases - **OE A&B&C**
  - Independent use of frequencies based on spectrum sensing capability - **OE C**
  - Frequency from VHF (30...88 MHz) to many GHz
- **Support of many waveforms**
  - National LRV/M18 waveforms, LTE, ESSOR, NBWF – **OE A&B&C**

Note: HF-communication plays important role in geographically wide country like Finland. HF-radio can be based on same technological solution but is a separate radio. Next generation HF-waveform should have following features:

- High data rate HF-modulation with wideband ALE
- Networked HF with full support of IP

Previous topics has been studied in Finland with following co-operation partners: KNL Networks(Oulu), TUT(Tampere), CWC(Oulu), VTT(Oulu)





# Cost-efficient WDE concept for SDR HH

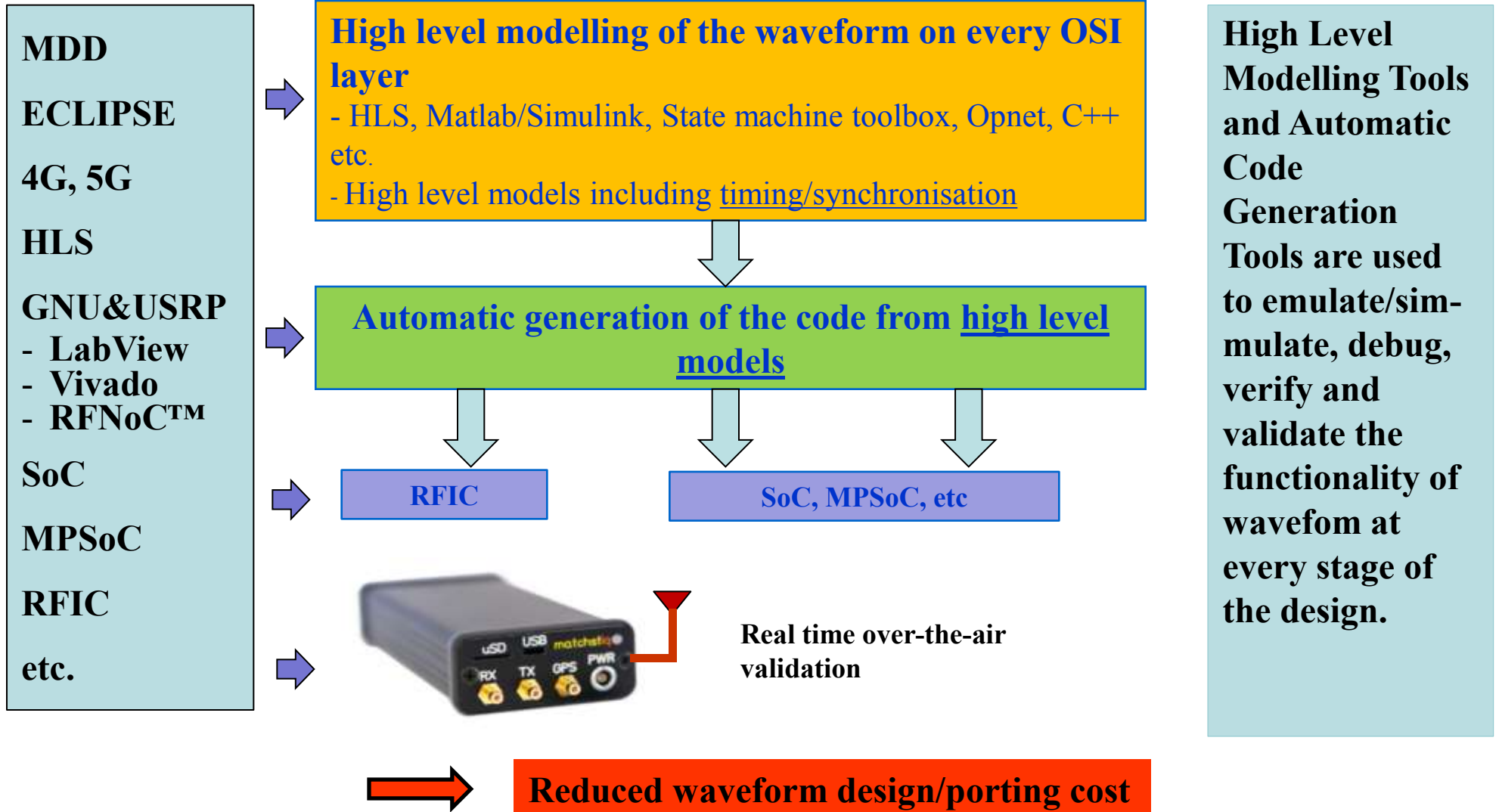



# From field test to emulation?

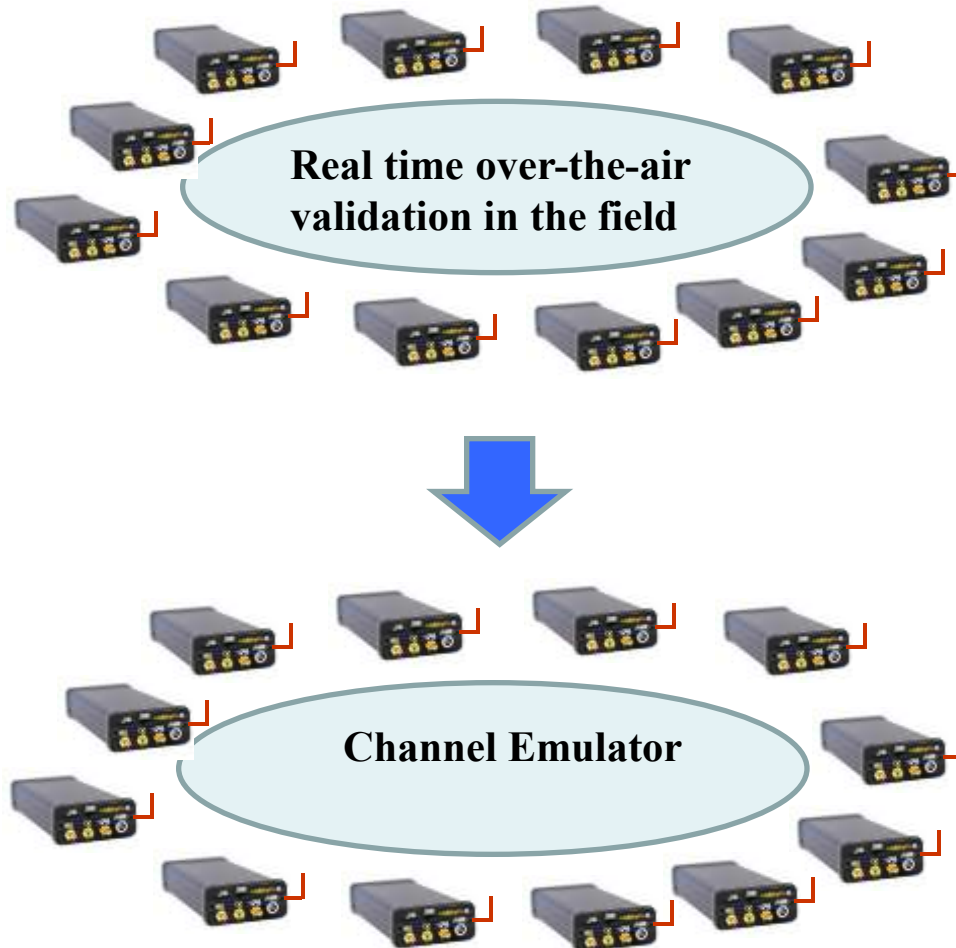

## Propsim Channel Emulator from Keysight

- Very high fidelity emulation of all mobile communication channels

- New features like Virtual Drive under development

→ Channel emulators are developing towards capability to emulate 10...15 node MANET network including mobility of nodes.

→ Must have product in certification of waveforms like ESSOR .





# Conclusions

Next generation SDR Handheld must support diversity of Operating Environments (A,B,C). In addition the implementation technology must be future proof and support primary/secondary spectrum use.

One could argue that in designing MIL SDR Handheld commercial approaches like implementing RFIC + SoC and advanced design tools and methods should be used.

Military forces have not yet recognized full potential of Cognitive Radio Technology.

The Finnish Defence Forces continues active contribution to the deployment of SDRs and further research on CR in military domain.



***Thank you !***

For more information contact:

Petteri Kuosmanen, Defence Command J6  
FIN SDR Program  
petteri.kuosmanen@mil.fi

Topi Tuukkanen, FDRA  
Cognitive radios and Networks  
topi.tuukkanen@mil.fi

Heikki Rantanen, FDRA  
SDR radio and Waveforms  
heikki.rantanen@mil.fi